

Article number: 201058300
 Description: E+G Handwheel
 GN 949-125-K14-D

Measures

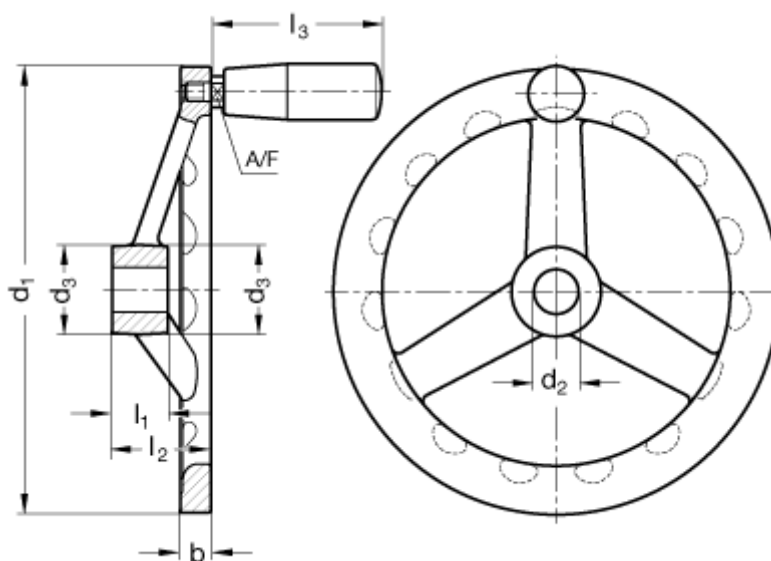

A/F	= 9	l3	= 55
b	= 9	Number of spokes	= 3
d1	= 125		
d2	= 14		
d3	= 24		
Handle diameter	= 21		
l1	= 16		
l2	= 28,5		